

Lecture 1: Introduction to Deep Learning

CSE599W: Spring 2018

Lecturers

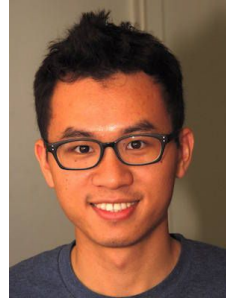
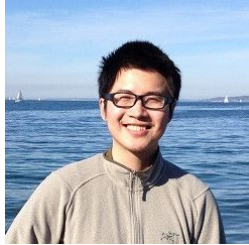

ML Applications need more than algorithms

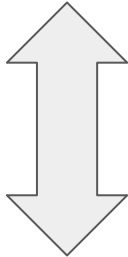
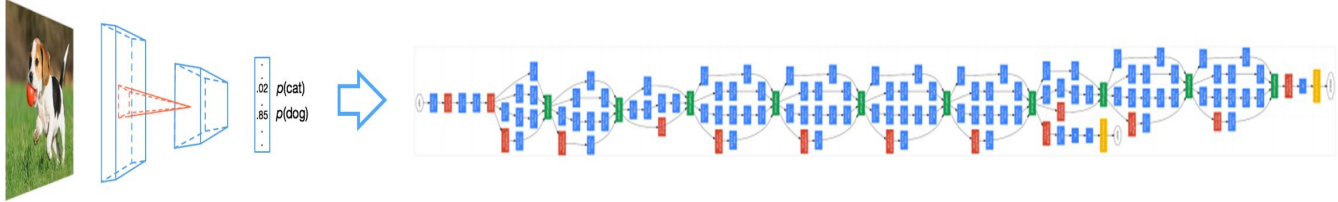

Learning Systems: this course



What's this course

- **Not** about Learning aspect of Deep Learning (except for the first two)
- System aspect of deep learning: faster training, efficient serving, lower memory consumption.

Logistics

- Location/Date: Tue/Thu 11:30 am - 12:50pm MUE 153
- Join slack: <https://uw-cse.slack.com> dlsys channel
- We may use other time and locations for invited speakers.
- Compute Resources: AWS Education, instruction sent via email.
- Office hour by appointment

Homeworks and Projects

- Two code assignments

- Group project
 - Two to three person team
 - Poster presentation and write-up

A Crash Course on Deep Learning

Elements of Machine Learning

Model



$$x_i = \begin{bmatrix} \text{feature}_0 \\ \text{feature}_1 \\ \dots \\ \text{feature}_m \end{bmatrix}$$



$$\hat{y}_i = \frac{1}{1 + \exp(-w^T x_i)}$$

Objective

$$L(w) = \sum_{i=1}^n l(y_i, \hat{y}_i) + \lambda \|w\|^2$$

Training

$$w \leftarrow w - \eta \nabla_w L(w)$$

What's Special About Deep Learning

**Compositional
Model**



**layer1
extractor**

**layer2
extractor**

predictor

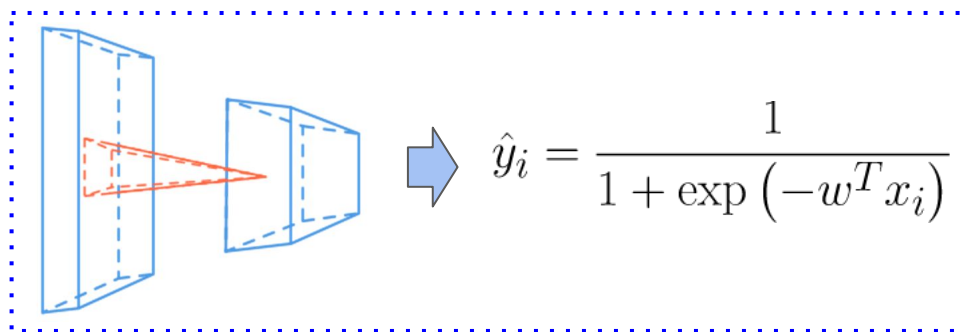

End to End Training

Ingredients in Deep Learning

- Model and architecture
- Objective function, training techniques
 - Which feedback should we use to guide the algorithm?
 - Supervised, RL, adversarial training.
- Regularization, initialization (coupled with modeling)
 - Dropout, Xavier
- Get enough amount of data

Major Architectures

Image Modeling Convolutional Nets

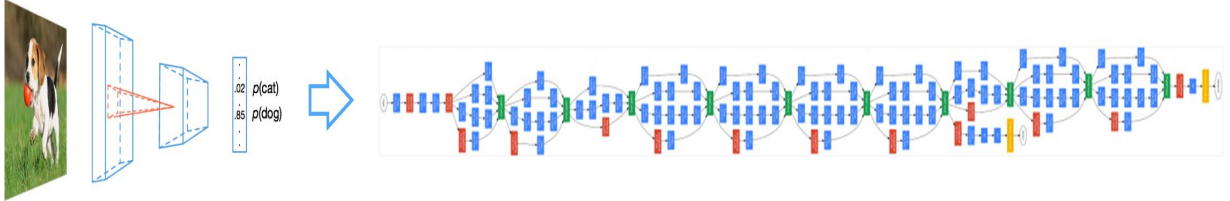

Language/Speech Recurrent Nets

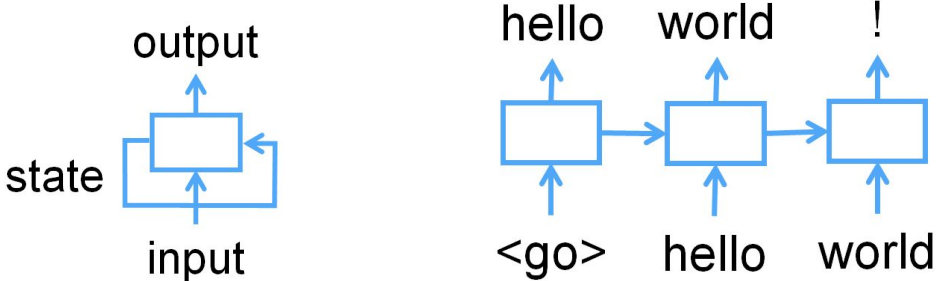
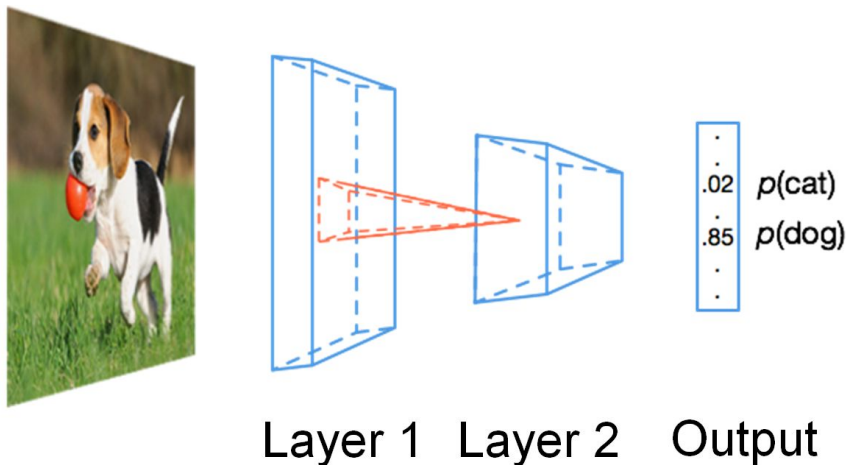
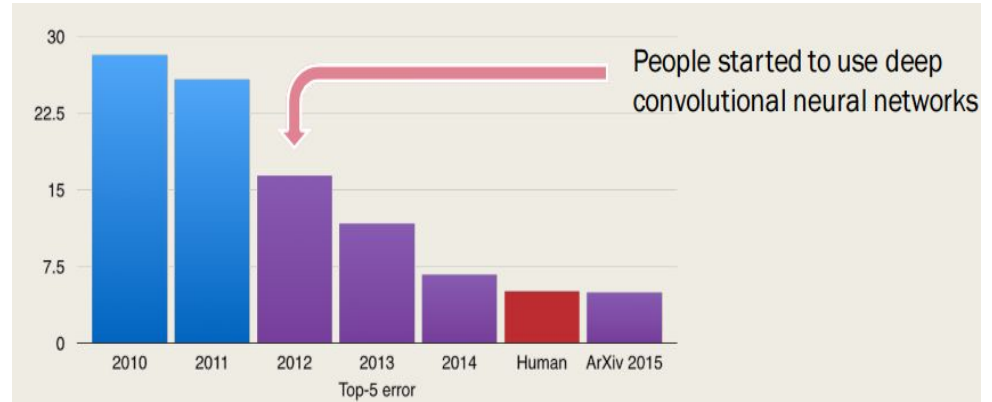
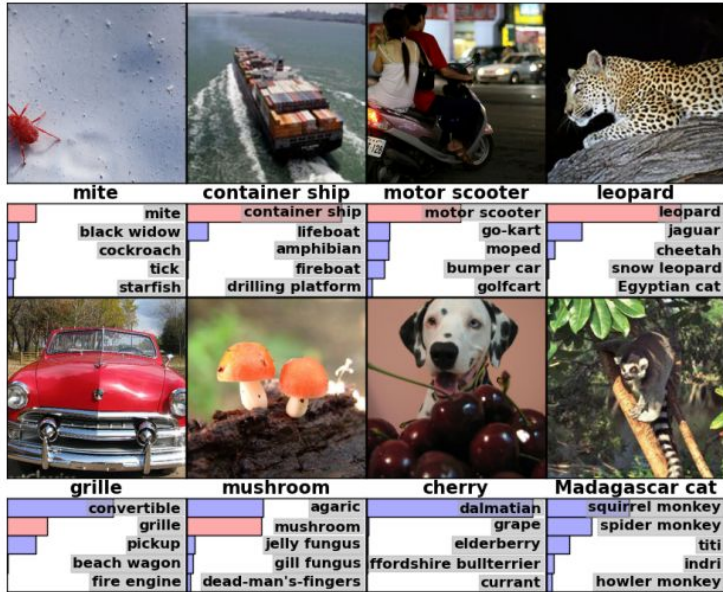

Image Modeling and Convolutional Nets



explore spatial information with convolution layers

Breakthrough of Image Classification



Evolution of ConvNets

- LeNet (LeCun, 1998)
 - Basic structures: convolution, max-pooling, softmax
- Alexnet (Krizhevsky et.al 2012)
 - ReLU, Dropout
- GoogLeNet (Szegedy et.al. 2014)
 - Multi-independent pass way (Sparse weight matrix)
- Inception BN (Ioffe et.al 2015)
 - Batch normalization
- Residual net (He et.al 2015)
 - Residual pass way

Fully Connected Layer

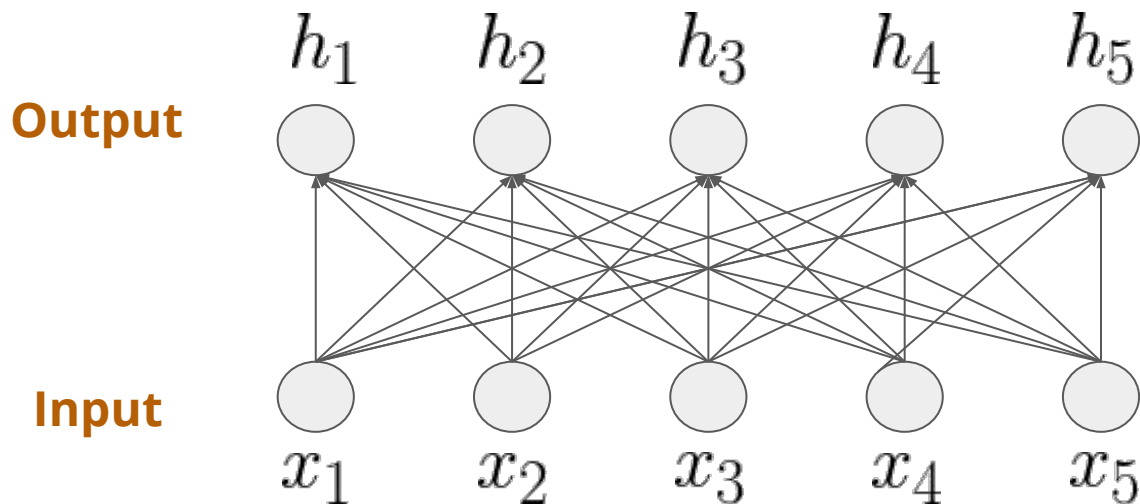

$$h_i = \sum_{j=1}^5 W_{ij}x_j$$

$$h_1 = W_{11}x_1 + W_{21}x_2 + W_{31}x_3 + W_{41}x_4 + W_{51}x_5$$

Convolution = Spatial Locality + Sharing

Spatial Locality

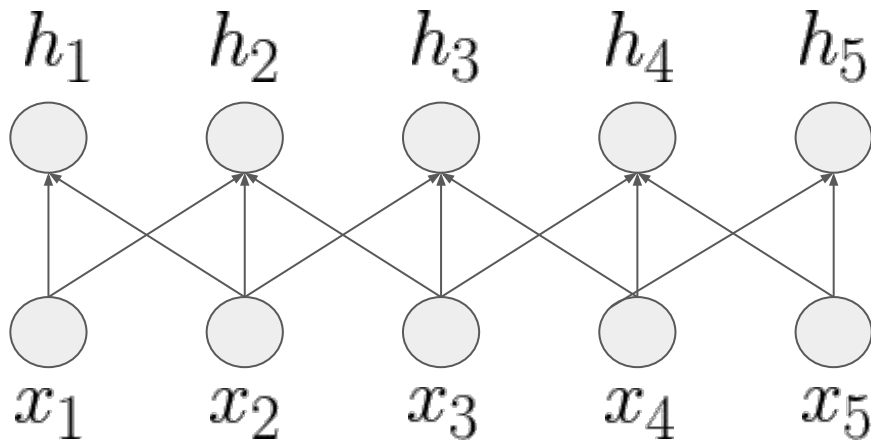

Without Sharing

$$h_i = W_{1,i}x_{i-1} + W_{2,i}x_i + W_{3,i}x_{i+1}$$

With Sharing

$$h_i = W_1x_{i-1} + W_2x_i + W_3x_{i+1}$$

Convolution with Multiple Channels

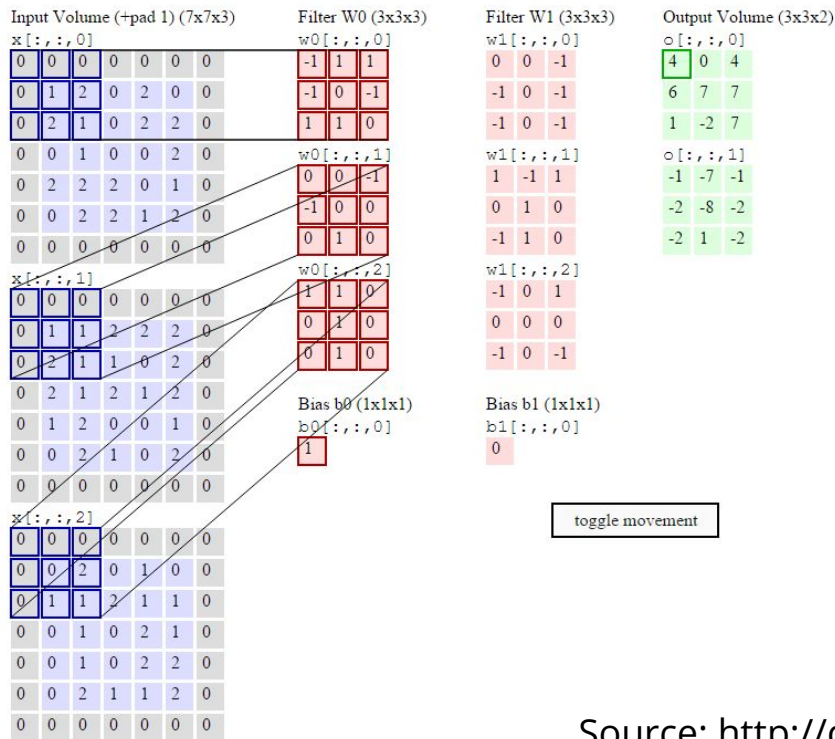

Source: <http://cs231n.github.io/convolutional-networks/>

Pooling Layer

Can be replaced by strided convolution

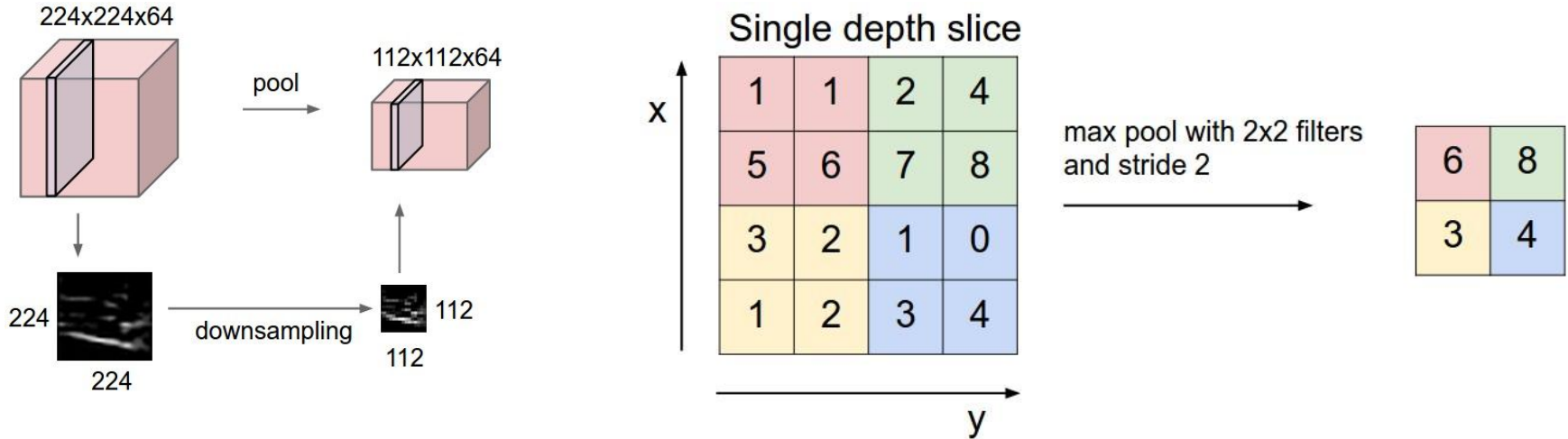

Source: <http://cs231n.github.io/convolutional-networks/>

LeNet (LeCun 1998)

- Convolution
- Pooling
- Flatten
- Fully connected
- Softmax output

$$p(i) = \frac{e^{\frac{f(i)}{T}}}{\sum_j e^{\frac{f(j)}{T}}}$$

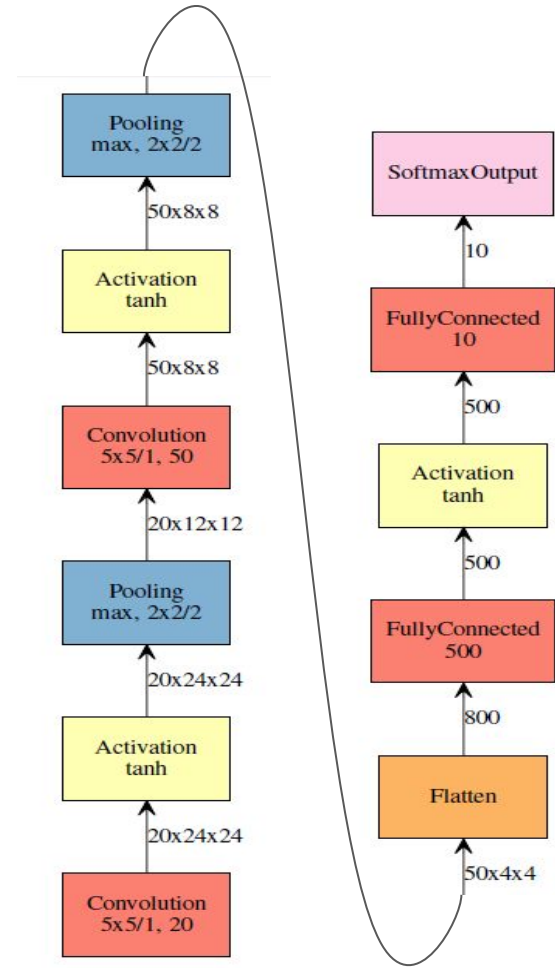

AlexNet (Krizhevsky et.al 2012)

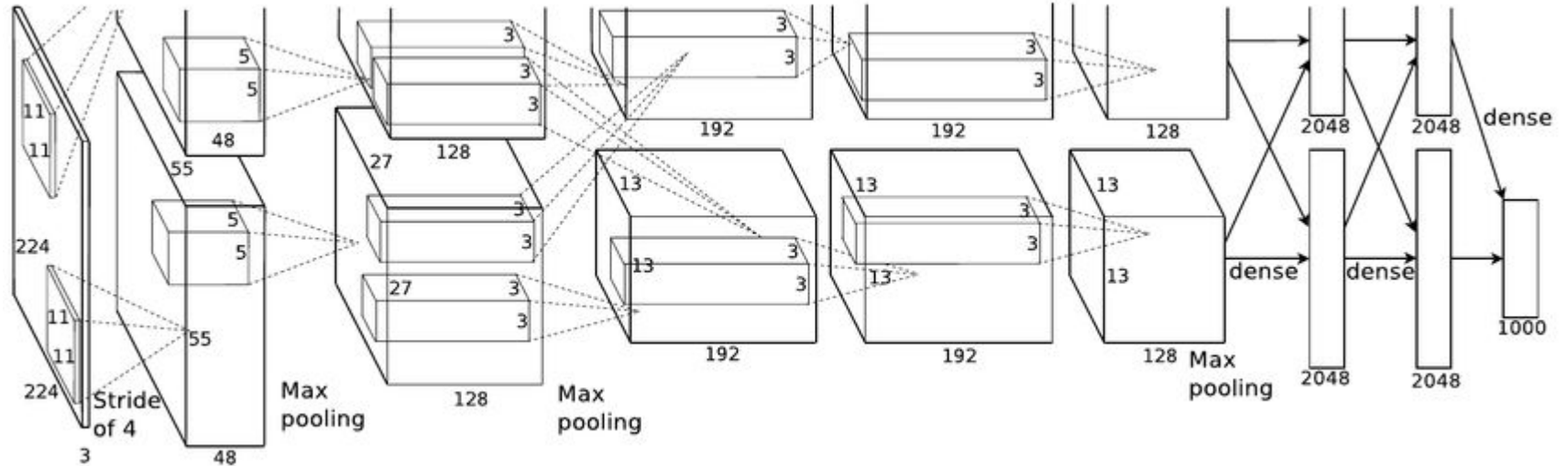

Challenges: From LeNet to AlexNet

- Need much more data: ImageNet
- A lot more computation burdens: GPU

- Overfitting prevention
 - Dropout regularization

- Stable initialization and training
 - Explosive/vanishing gradient problems
 - Requires careful tuning of initialization and data normalization

ReLU Unit

- ReLU $y = \max(x, 0)$
- Why ReLU?
 - Cheap to compute
 - It is roughly linear..

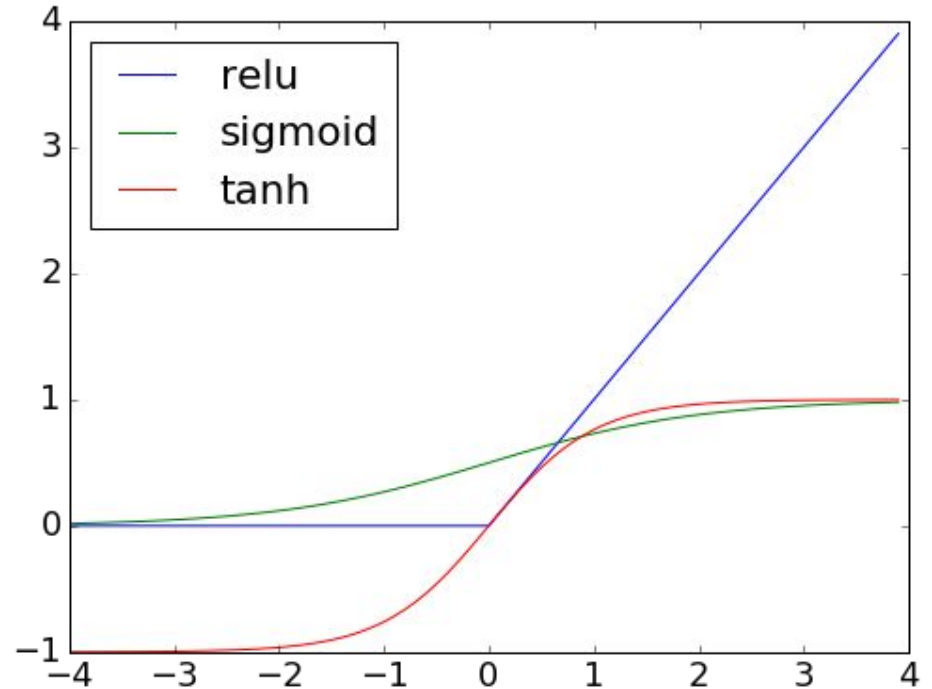

Dropout Regularization

- Randomly zero out neurons with probability 0.5
- During prediction, use expectation value (keep all neurons but scale output by 0.5)

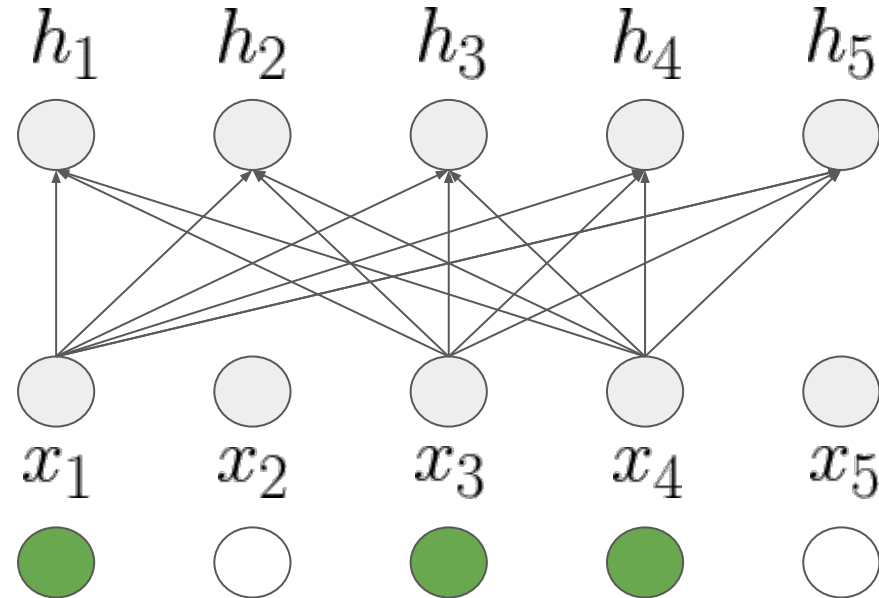

Dropout Regularization

- Randomly zero out neurons with probability 0.5
- During prediction, use expectation value (keep all neurons but scale output by 0.5)

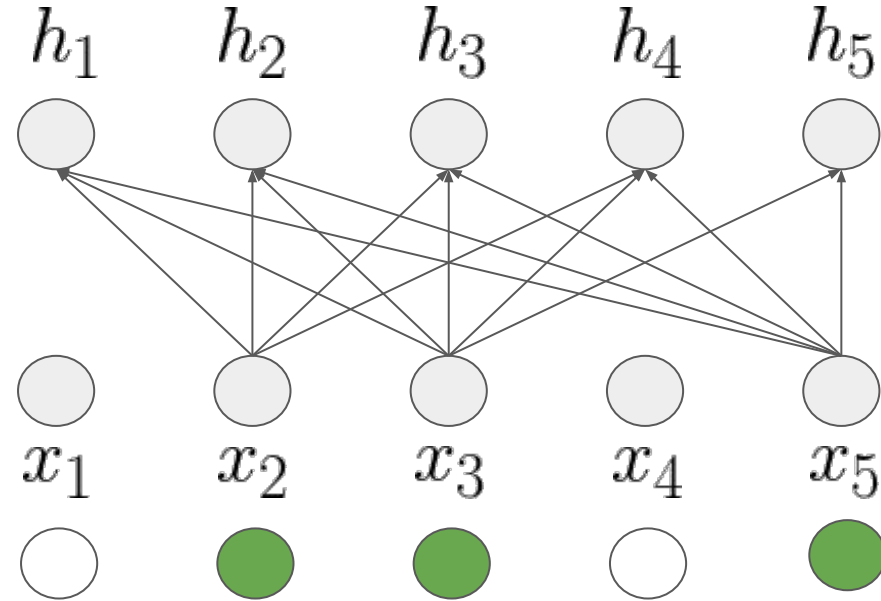

GoogleNet: Multiple Pathways, Less Parameters

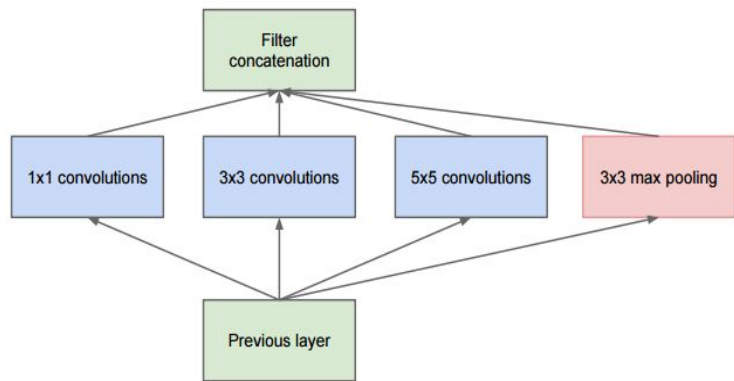

(a) Inception module, naïve version

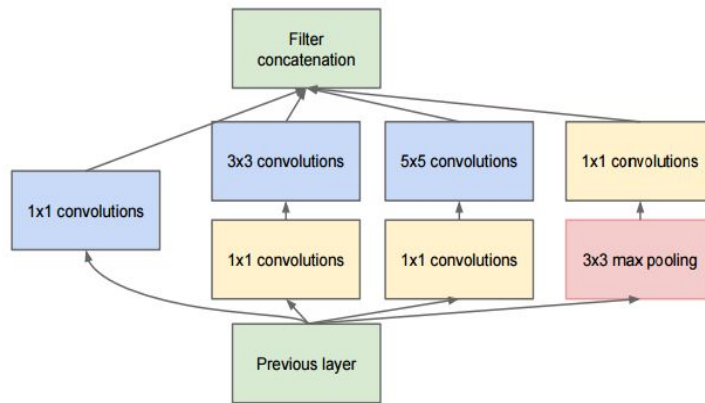

(b) Inception module with dimension reductions

Figure 2: Inception module

Vanishing and Explosive Value Problem

- Imagine each layer multiplies its input by same weight matrix

- $W > 1$: exponential explosion
- $W < 1$: exponential vanishing

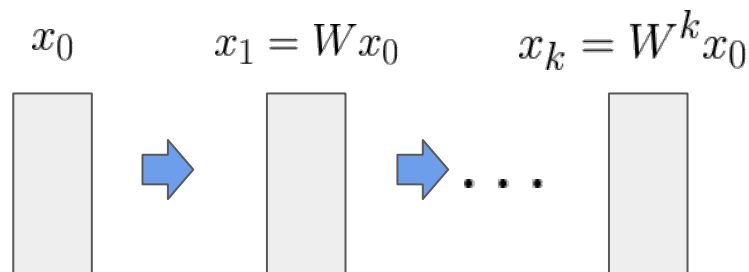

- In ConvNets, the weights are not tied, but their magnitude matters
 - Deep nets training **was** initialization sensitive

Batch Normalization: Stabilize the Magnitude

- Subtract mean
- Divide by standard deviation
- Output is invariant to input scale!
 - Scale input by a constant
 - Output of BN remains the same
- Impact
 - Easy to tune learning rate
 - Less sensitive initialization

Input: Values of x over a mini-batch: $\mathcal{B} = \{x_{1\dots m}\}$;
Parameters to be learned: γ, β

Output: $\{y_i = \text{BN}_{\gamma, \beta}(x_i)\}$

$$\mu_{\mathcal{B}} \leftarrow \frac{1}{m} \sum_{i=1}^m x_i \quad // \text{ mini-batch mean}$$

$$\sigma_{\mathcal{B}}^2 \leftarrow \frac{1}{m} \sum_{i=1}^m (x_i - \mu_{\mathcal{B}})^2 \quad // \text{ mini-batch variance}$$

$$\hat{x}_i \leftarrow \frac{x_i - \mu_{\mathcal{B}}}{\sqrt{\sigma_{\mathcal{B}}^2 + \epsilon}} \quad // \text{ normalize}$$

$$y_i \leftarrow \gamma \hat{x}_i + \beta \equiv \text{BN}_{\gamma, \beta}(x_i) \quad // \text{ scale and shift}$$

Algorithm 1: Batch Normalizing Transform, applied to activation x over a mini-batch.

(Ioffe et.al 2015)

The Scale Normalization (Assumes zero mean)

**Scale
Normalization**

$$BN(x)_i = \frac{x_i}{\sqrt{\sum_{j=1}^m x_j^2}}$$

**Invariance to
Magnitude!**

$$BN(\alpha x)_i = \frac{\alpha x_i}{\sqrt{\sum_{j=1}^m (\alpha x_j)^2}} = BN(x)_i$$

Residual Net (He et.al 2015)

- Instead of doing transformation add transformation result to input
- Partly solve vanishing/explosive value problem

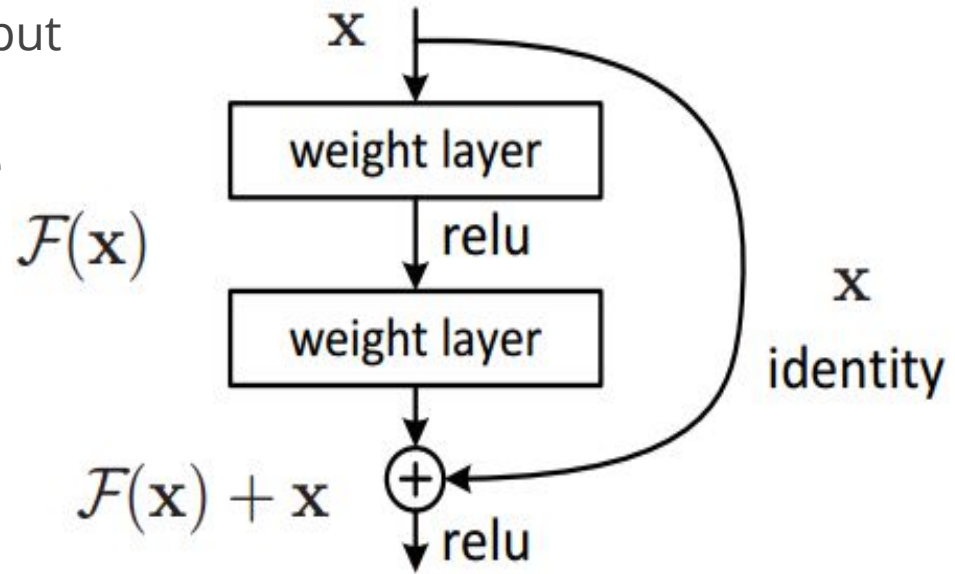

Evolution of ConvNets

- LeNet (LeCun, 1998)
 - Basic structures: convolution, max-pooling, softmax
- Alexnet (Krizhevsky et.al 2012)
 - ReLU, Dropout
- GoogLeNet (Szegedy et.al. 2014)
 - Multi-independent pass way (Sparse weight matrix)
- Inception BN (Ioffe et.al 2015)
 - Batch normalization
- Residual net (He et.al 2015)
 - Residual pass way

More Resources

- Deep learning book (Goodfellow et. al)
- Stanford CS231n: Convolutional Neural Networks for Visual Recognition
- <http://dlsys.cs.washington.edu/materials>

Lab1 on Thursday

- Walk through how to implement a simple model for digit recognition using MXNet Gluon
- Focus is on data I/O, model definition and typical training loop
- Familiarize with typical framework APIs for vision tasks
- **Before class:** sign up for AWS educate credits
- <https://aws.amazon.com/education/awse educate/apply/>
- Create **AWS Educate Starter Account** to avoid getting charged
- Will email out instructions, but very simple to DIY, so do it today!